

8 DEALER MANUAL FOR BT F15.655.C/ BT F15.730.C



CONTENT

8.1 Introductions	2	8.2 Operation	5
8.1.1 Battery	2	8.2.1 Installing the battery.....	5
8.1.1.1 Safety Instructions.....	2	8.2.2 Removing the battery.....	5
8.1.1.2 Battery Storage.....	3	8.2.3 Charging the Battery.....	6
8.1.1.3 Battery Wear.....	3	8.2.3.1 Safety Instructions.....	6
8.1.1.4 Pedelec Riding Distance.....	3	8.3 Specifications	7
8.1.2 Charger.....	4	8.3.1 Battery.....	7
8.1.2.1 Battery charger Instructions.....	4		

8.1 INSTRUCTIONS

8.1.1 Battery

 Your pedelec can be equipped with different battery types.

(Depending on the manufacturer's configuration)

Model numbers:

BT F15.655.C/ BT F15.730.C



 Before use, read the information on the label of the battery.

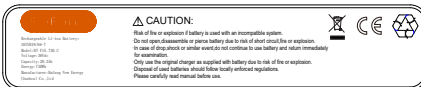
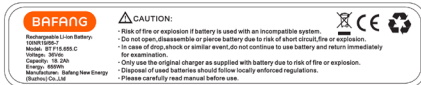



 Please only use the original BAFANG charger to charge the battery. The battery is not fully charged when it is delivered. Please charge the battery completely before its first use and before storage.

- It is recommended to charge the battery after use. Deep discharge is harmful to the battery. Never fully discharge the battery. If the battery remains uncharged for an extended period, this will damage the capacity of the battery. For storage, the recommended capacity of the battery should be between (60-80%).
- Do not charge the battery longer than the charging time specified in the "SPECIFICATION" table.

8.1.1.1 Safety instructions

 It is possible for the battery to cause a fire, explosion or hazard if the battery is connected to an incompatible system. Do not open, disassemble or pierce the battery as this can lead to short circuits, leaks, fires or explosions. If the battery falls to the ground, or exposed to a blow or similar event, do not continue to use the battery, take it to your retailer to examine. Use only the original charger supplied with the battery, otherwise it can lead to an explosion or permanent damage. The disposal of used batteries must be carried out at a suitable disposal point.

 **The battery should always be kept out of reach of children. The use of the charger or the battery is not suitable for children.**

 **Do not touch a leaking battery.** Leaking electrolytes can seep into the skin and cause discomfort. If battery acid encounters the eyes, do not rub it! Immediately wash your eyes carefully with clean water and consult a doctor or a hospital.

 **A faulty battery can lead to overheating, smoking or burning.**

When the battery gets hot keep yourself and others a safe distance away from the battery. In case of damage or heat, you should avoid touching the battery. See chapter ("Environmental tips").

 **Do not disassemble the battery.** The battery contains protective components to avoid danger. Incorrect handling, such as improper disassembly, can destroy the protective functions and lead to overheating, smoke and explosion.

 **Do not intentionally short-circuit the battery.**

Never allow the plus and minus connectors to come into contact with each other. Do not allow the battery to come into contact with

metal objects. It is dangerous if the battery is short-circuited. As it can lead to overheating, smoke, explosion or burning.



Do not heat or burn the battery.

An overheated or ignited battery can cause battery cells to explode.



Do not use the battery near heat sources.

Do not use the battery near an open flame or at temperatures above 60 °C. High temperatures can cause the battery to burn or explode.



Do not charge the battery near open fire or in direct sunlight.

This can cause errors or internal problems inside the battery, also damaging the protective function. It can lead to abnormal chemical reactions or malfunctions that lead to overheating, smoke and explosion.



Do not damage the battery.

The battery must not be dropped or damaged. This can lead to overheating, smoke and explosion. Never submerge the battery in water.



Do not charge the battery directly from the socket or a cigarette lighter in the car.

High voltage and excessive current will damage the battery and reduce its lifespan. It can lead to overheating, smoke and explosion.

8.1.1.2 Battery Storage



If you do not use your pedelec for a long time, remove the battery, and charge about (60-80%) on. Store the battery separately in a suitable dry place.

- Avoid direct sunlight from the sun, as it may cause it to overheat, and cause internal problems in the battery. It can lead to abnormal chemical reactions or malfunctions that lead to overheating, smoke and explosion.
- To prevent a deep discharge, the battery is

put into sleep mode after a certain time.

- Do not extend the battery to temperatures below the permissible storage temperature of -10 °C to 35 °C. Note that temperatures of about 45 °C are common near heaters, in direct sunlight or in overheated vehicle interiors.



Do not continue to use the battery if you notice that it gets hot during operation, charging or storage, develops a strong smell, changes its appearance, or is otherwise unusual. Do not continue to use the battery and have it checked by a retailer before using it again.

8.1.1.3 Battery wear



The battery can be charged 600 times. The battery capacity decreases during this time, thus reducing the range of the pedelec. If the battery's capacity range is not enough, it may need to be replaced.

8.1.1.4 Pedelec riding distance



It is best to charge the battery at room temperatures and insert the battery just before the start of the journey. The discharge cycle of the battery can be affected by:

- Used pedal power
- Total weight (load and driver)
- Tire air pressure
- Headwind
- Ambient temperature
- Road/underground condition
- selected speed level
- Slope
- Battery charge level
- Age
- Remaining capacity of the battery

8.1.2 Charger

8.1.2.1 Battery charger Instructions



To prevent the risk of electric shock, you should never open the charger. Maintenance work may only be carried out by qualified service personnel. Be sure to read the information about your charger before use! Unplug the power plug before connecting the battery to the charger or removing it from the charger.



Keep the charger away from children and animals. In the event of malfunction or damage, it may result in a fire or electric shock.

- The charger must not be operated by children or people with limited sensory or mental disabilities.
- Do not use your charger if it is moist or dusty.
- Avoid direct sunlight.
- Disconnect the charger from the power supply when not in use.
- Use only the original Bafang charger that came with your pedelec.
- Do not cover the charger while in use. There is the possibility of short circuits or fires.
- When cleaning the charger, unplug it from the power outlet first.
- Stop the Charge process if the charging cycle lasts longer than the length listed in the Specifications table.

8.2 OPERATION

8.2.1 Installing the battery

i For correct insertion, the battery must be connected, ensuring all pins are correctly connected to the battery holder. When pushing the battery into position. Make sure that the battery has clicked into the locking mechanism before you set off.

1. Insert the upper holding bracket and the bottom support bracket into the frame and fix them into position with M5*10 screws.

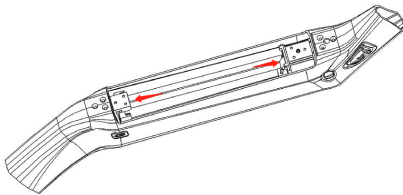

2. Fasten the limiting stopper onto the frame with M3*10 screws.

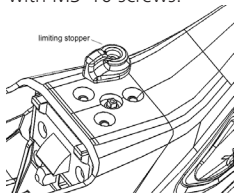

3. Place the bottom part of the battery into the frame, making sure it sits comfortably on the bottom support bracket.

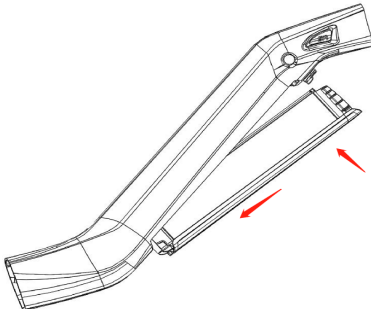

4. Push the top part of the battery into the frame, until you hear the battery lock into position, and turn the limiting stopper to keep the battery from dropping.

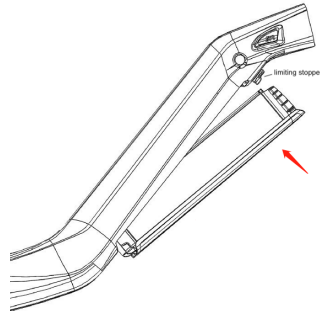

8.2.2 Removing the battery

1. Turn the key in the frame to open the first locking mechanism of the battery.

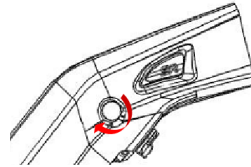

2. Push limiting stopper to release the second locking mechanism and take off the battery.

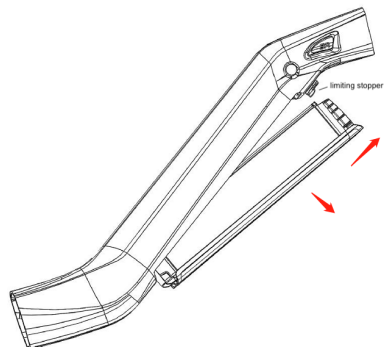

8.2.3 Charging the battery



Use only the original battery charger supplied to you, as there is a risk of fire or explosion if the incorrect charger is used.



You can charge your battery when mounted on the bike or when it is removed.



Lithium-ion batteries are not subject to any memory effect. You can recharge your battery at any time, even after short journeys.

Charge the battery at temperatures between 0°C and 45°C (ideally at room temperature approx. 20 °C). Give your battery enough time to reach this temperature before charging.



The charging time depends on several factors. It can vary greatly depending on the temperature, age, use and capacity of the battery. For information on the charging time of your battery, see "**SPECIFICATION**".

When the battery is fully charged, the charging process stops automatically. Unplug the connector from the battery and then removed from the mains.

8.2.3.1 Safety instructions



Use only the battery charger.

Make sure you are using the correct mains voltage. The required mains voltage is indicated on the charger.

Errors - Causes and Solutions

Description	Cause	Solution
The operating display does not light up.	Power plug is not correctly connected to the power supply	Check that all connectors on the charger are correctly connected to the power supply.
The charging indicator does not light up.	The battery may be malfunctioning.	Contact your retailer.

- Do not touch the power plug with wet hands. There is a risk of electric shock.
- Note: A sudden rise in temperature can cause condensation in the battery. To avoid condensation, charge the battery at the same place where it is stored.
- Before using, check that the charger, cable and plug are not damaged. Do not use the charger, if you notice any damage. There is a risk of electric shock.
- Charge the battery only in a well-ventilated room.
- Do not cover the charger/battery during charging. There is a risk of overheating, fire or explosion.
- Charge the battery in a dry place, and on a non-flammable surface.



The battery must be charged at least once every 3 months to avoid damage or destruction of the cells.



If the charging process takes longer than usual, the battery may be damaged. In this case, stop charging immediately. Have the battery and charger checked by your retailer to prevent further damage.

8.3 SPECIFICATIONS

8.3.1 Battery

Primary Settings	BT F15.655.C	BT F15.730.C
Nominal Voltage	36 Vdc	36 Vdc
Nominal Capacity	18.2 Ah	20.3 Ah
Min Capacity	17.5 Ah (1C Discharge)	19.25 Ah (1C Discharge)
Energy	655 Wh	730 Wh
Charging Time	7h with 3A Charger	8h with 3A Charger
Storage (At 35% SOC & -10° ~ 35 °C)	6 months	6 months
Dimensions (L * W * H)	442.1*97.6*91mm	442.1*97.6*91mm
Weight	4.3KG	4.3KG
Charger	Customer specified	Customer specified

* Ideal conditions: Flat terrain, approx. 15km/h average speed, no headwind, approx. 20 °C ambient temperature, high-quality bike components, tire tread and pressure with minimal rolling resistance, experienced eBike rider(always shifts gears correctly), additional weight(excluding bike weight)<70kg.